



VAN BERKEL INTERNATIONAL

## USER MANUAL FOR

---

936/937 Series



Van Berkel International S.r.l.  
via Ugo Foscolo, 22  
21040 Oggiona S. Stefano (VA) - ITALY  
T +39 0331 214311  
info@berkelinternational.com  
[www.theberkelworld.com](http://www.theberkelworld.com)

# Contents

<b>1. General Information</b>	<b>4</b>
1.1. Notes regarding the operating instructions	4
1.2. Notes regarding warranty	4
1.3. Notes regarding security	5
1.4. Dimensions of the machine and technical data	5
1.5. Description of the machine	6
1.5.1. General plan of the machine	7
1.6. Usage	7
<b>2. Installation and initial operation</b>	<b>8</b>
2.1. Checking the contents of the carton	8
2.2. Installation	8
2.3. Electrical installation	9
2.4. Checking the direction of blade rotation	9
<b>3. Operation</b>	<b>9</b>
3.1. Important notes before switching on the machine	9
3.2. Switch functions (push button)	9
3.3. Thickness of slices	10
3.4. Operation of the end piece holder	10
3.5. Automatic or manual movement of the carriage	10
3.6. Automatic operation	11
3.6.1. Engaging carriage	11
3.6.2. Loading the carriage and adjusting the thickness of slices	11
3.6.3. Adjusting the speed of the carriage	11
3.6.4. Notes regarding the slicing programme	12
3.7. Manual operation	12
3.7.1. Disengaging carriage	12
3.7.2. Loading the carriage and adjusting the thickness of slices	12
3.7.3. Notes regarding the slicing programme	12
<b>4. Slicing functions</b>	<b>13</b>
4.1. Description of the keyboard	13
4.2. Starting the slicing programme	13
4.3. Changing the slicing programme	14
4.3.1. Stacking	15
4.3.2. Shingling lengthwise	16
4.3.3. Shingling crosswise	17
4.3.4. Circle shingling	18
<b>5. Programmed Operation (PLU)</b>	<b>20</b>
5.1. Choosing PLU-Number	20
5.2. Data conditioning	21
5.2.1. Create article and modify data	22
5.2.2. Copy article	23
5.2.3. Delete article	23
5.2.4. Modify article	24
<b>6. Slicing of end pieces</b>	<b>24</b>

<b>7. Cleaning</b>	<b>25</b>
<hr/>	
7.1. Taking off parts of carriage	25
7.2. Taking off the blade guard	27
7.3. Taking off staking device and chain frame	27
7.4. Taking off deflector and receiving plate	27
7.5. Cleaning the blade	28
7.5.1. Cleaning the front of the knife	28
7.5.2. Removing and cleaning the knife	28
7.5.3. Cleaning the inside of the knife ring guard	29
7.5.4. Refit the knife	28
7.6. Cleaning the single parts	29
7.7. Reassembling the parts	30
<b>8. Sharpening the blade</b>	<b>30</b>
<hr/>	
8.1. Sharpening device	30
8.2. Using the sharpening device	30
8.3. Sharpening the blade	31
8.4. Repositioning the sharpener	31
8.5. Mounting the removable sharpening device	31
8.6. Sharpening the blade	32
8.7. Remove the removable sharpening device	32
<b>9. Maintenance</b>	<b>333</b>
<hr/>	
9.1. Lubrification of sliding bars - End piece holder and receiving tray	33
9.2. Lubrification of stacking device, blade protection and adjusting bar of the carriage	33
9.3. Lubrification of adjusting bar (fence) of the carriage and the roller deflector bearing	34
<b>10. Trouble shooting</b>	<b>35</b>
<hr/>	
10.1. Error messages on the display	35
<b>11. Waste disposal</b>	<b>36</b>
<hr/>	
<b>Additional operation instructions for conveyor belt</b>	
<b>12. Dimensions and description of the machine</b>	<b>37</b>
<hr/>	
12.1. Dimensions of the machine and technical data	37
12.2. Description of the machine	38
12.3. General plan of the machine	38
12.4. Usage	39
12.5. Installation and initial operation	39
12.6. Installation	39
12.7. Electrical installation	39
<b>13. Operation</b>	<b>40</b>
<hr/>	
<b>14. Cleaning</b>	<b>40</b>
<hr/>	

## 1. General Information

### 1.1. Notes regarding the operating instructions

Read the following hints before installing and operating this machine!

Make yourself familiar with this machine by reading this operating instructions carefully.

Within this operating instructions there are indicated the following safety notes and hints:



means **Attention**. Notes for probable danger and for avoiding mistakes.



means **notes** and **hints** regarding certain operation procedures.

### 1.2 Notes regarding warranty

The installation and initial operation should be carried out by an authorised supplier or service technician.

Only trained personnel are allowed to operate this machine. When required, the training has to be repeated.

Supervisory and operating staff must read the operating instructions carefully before initial operation of this machine. Starting, operating and cleaning have to be done according the operating instructions and are only allowed after having been introduced to the correct way of working.

In case of:

- unauthorised installation
- unauthorised electrical installation
- incorrect operation
- misuse
- constructional alteration
- detaching security or protecting equipment
- and in case of using non-original Berkel spare parts

#### **Berkel does NOT take any responsibility**

In above case the operator acts on his own risk and is wholly responsible for damage which might occur.

#### **Therefore, only use original Berkel spare parts!**



**In case high pressure or steam cleaning devices or high pressure water is used all claims regarding warranty will be refused.**

This is valid also for faults and damages which are caused by natural wear and tear.

The pictorial representation might differ from the machine supplied because of regional specific requirements or as a result of technical improvement.

The contents of this operating instructions is not affected by that.

### 1.3. Notes regarding security

This machine corresponds to legal security and hygienic requirements. Nevertheless there is a risk of injury in the case of incorrect or inattentive operation or maintenance. Especially hands and fingers are at risk of injury. Staff operating this machine must be fully trained on the correct procedures for operation and maintenance in accordance with these operating instructions.

Pay attention in any case to the following notes regarding security:



**See to it that unauthorised, untrained personnel and in particular children cannot start the machine. It is not allowed to detach, to modify or to disregard protecting or security equipment. This could result in a high risk of injury.**

Always work with concentration, do not let distract yourself from your work.

Only cut food products as indicated in this operating instructions.

Never carry out experiments. Never try to cut foreign material.

Never cut deep frozen products.

Never check the sharpness of the blade with your fingers.

Never detach the blade without supplied knife remover.

Never use the machine as a place to put something on or to do other work on.

Take care that the floor space is clean, dry and non-slip.

In case the current supply cable or the plug are defective, these parts have to be exchanged or repaired by your after sales service or an electrician.

Before cleaning remove the plug from the electrical socket before proceeding .

If the machine makes an unusual noise switch off the machine immediately.

In case the fault cannot be corrected by the operator, contact authorised after sales service.

### 1.4. Dimensions of the machine and technical data (only for 936 version)

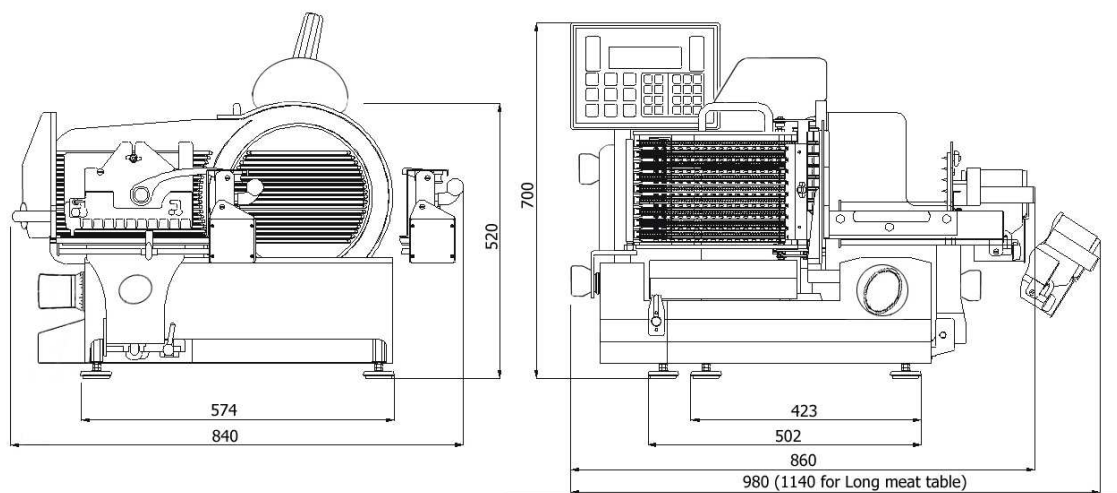

Overall dimensions	( 840x980x700h mm <u>standard table</u> ) and ( 840x1140x700h mm <u>long meat table</u> )
Foot distance	574x502 mm
Max. cutting size	ca. 255x195h mm
Thickness of slices	0 - 10 mm (infinitely variable)
Diameter of blade	330 mm
Sound level	< 54 db(A)
Weight	about 87 kg
Voltage and cycles	see rating plate
Power	0,9 kW

### **1.5. Description of the machine**

This food slicer is fully automatic with integrated shingling and stacking device.

The carriage is moved automatically. For operation, cleaning and sharpening the automatic drive of the carriage can be disengaged.

The blade is driven electrically with a 1-phase or 3-phase geared motor. This geared motor is maintenance-free and air-cooled.

By means of a special air circulation the warming up of the motor is very low, especially around the blade.

The automatic carriage is moved by a strong d.c. motor.

The food product is pushed against the blade by a fully automatic end piece holder.

The material used in the food zone corresponds to all requirements of food hygiene.

The complete machine body, the thickness plate, the blade guard and the carriage are made of stainless steel.

The blade is hard chromed.

All visible bearings as well as open sliding surfaces are lubricated only with lubricant suitable for food zones.

For switching the machine on and off double white / red push button is used

Self-starting of the machine after a voltage drop is avoided by the electric control.

There are internal fuses to protect the electronic control, the motors are controlled electronically.

The carriage can only be tilted aside when the automatic drive is disengaged and the thickness plate is closed completely.

When the carriage is tilted aside, the thickness plate is locked in this position and cannot be opened

The protecting and security equipment as well as electrical and mechanical components correspond to regulations in force.

The machine is equipped with the following security equipment:

- no self-starting of the machine after a voltage drop
- fully automatic stop of the blade
- double push-button control
- fixed ring around the blade, non-removable
- central blade protection, fixed, removable
- locked thickness plate when the carriage is tilted aside
- internal fuses for current supply and electronic control

### 1.5.1. General plan of the machine

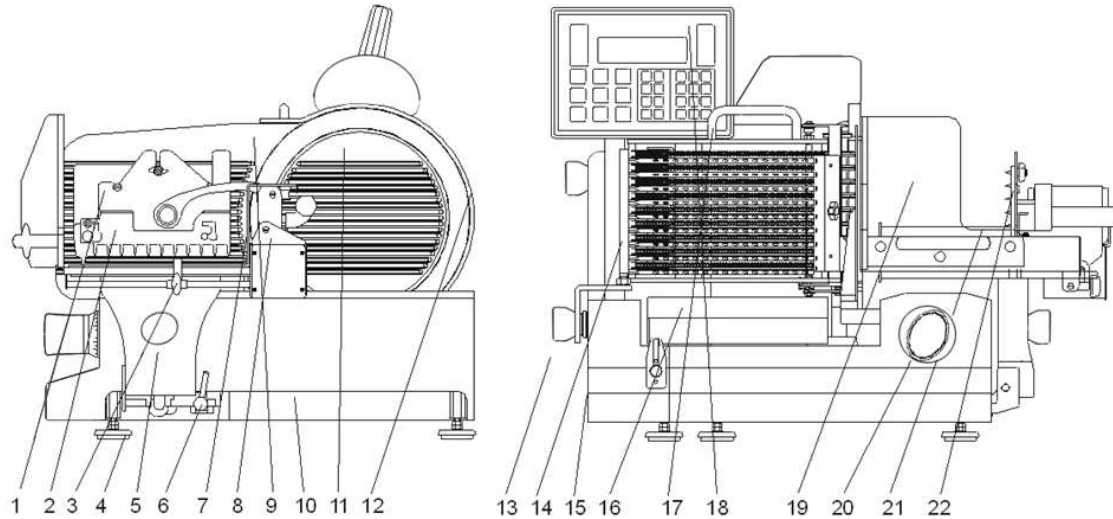

- |                          |                              |                                   |
|--------------------------|------------------------------|-----------------------------------|
| 1 End piece holder       | 10 Guiding axle carriage     | 19 Hand protection                |
| 2 Comb, end piece holder | 11 Blade guard               | 20 Thickness knob                 |
| 3 Adjusting bar          | 12 Fixed ring                | 21 Guiding axle, end piece holder |
| 4 Rubber foot            | 13 Star knob stacking device | 22 Plate of end piece holder      |
| 5 Star knob for carriage | 14 Stacking device           |                                   |
| 6 Lever                  | 15 Rating plate              |                                   |
| 7 Carriage feed plate    | 16 Receiving plate           |                                   |
| 8 Carriage               | 17 Chain frame               |                                   |
| 9 Thickness plate        | 18 Display and keyboard      |                                   |

### 1.6. Usage

The following food products can be sliced by taking into account the maximum cutting capacity:

- - all kinds of sausages
- - ham / bacon
- - roast meat / cooked ham
- - meat
- - cheese

The following products are not allowed to be sliced because of danger to get injured:



- **NON FOOD** articles
- food products with bones
- deep frozen food products

The machine should be installed in a retail environment. The room temperature must not be under 10°C and not over 40°C.

The machine is drip-proof only.

High air humidity and condensation water may damage the machine. The machine is **not splash-proof**.

## 2. Installation and initial operation



**First read the operating instructions very carefully!**

**Pay close attention to all notes.**

**Operating procedures have to be carried out as described.**

**Always work carefully and concentrate, this should prevent damage and injuries**

**The installation, introduction and initial operation has to be done by an authorised supplier or service technician.**

### 2.1. Checking the contents of the carton

The supplied carton has to have to following contents:

- Berkel food slicer model 936-937

as well as the following equipment:

- chain frame
- stacking device
- receiving plate or conveyor belt
- Knife remover and screwdriver
- table for food slicer (only for machines with conveyor belt)
- these operating instructions

### 2.2. Installation



**The food slicer model 936-937 has to be installed on a plain, horizontal, non-slip and stable surface. If necessary the machine should be clamped down in position**

Recommended working height of the work surface about 800 mm.

Pay attention to the required counter space.

Place the chain frame upon the 3 locating positions .

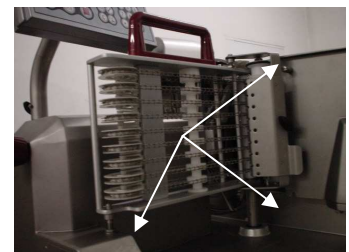

Place the stacking device upon its location bush and screw it tight.

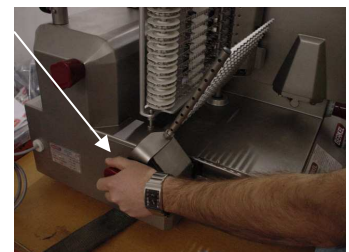

Place the receiving plate upon the machine.

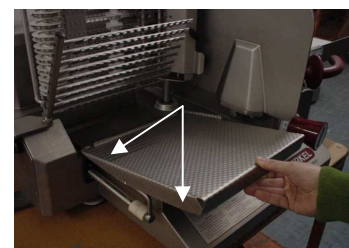



### 2.3. Electrical installation

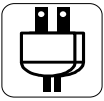

Before you plug in the machine, you have to check if the current supply is the same as indicated on the rating plate. In case there are discrepancies you have to inform the supplier or technical service.

**Under no circumstances plug in the machine!**

The socket-outlet has to be equipped with earthing contact. It has to be connected according to customary regulations. A defective socket-outlet may damage the machine or endanger the operator.

In case it is necessary to exchange the plug, this has to be done by an electrician or the after sales service.

### 2.4. Checking the direction of blade rotation (for 3 phase motors only)

Switch on the machine.

Close completely the tickness plate

Push the ON white button  → Display is illuminated.

Push the key "cleaning" on the display 

The blade has to rotate in direction of arrow (counter clockwise).

The blade is stopped by pushing again the "cleaning" key 

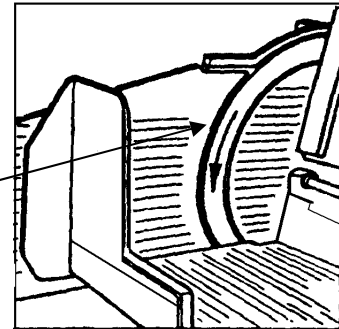

**In case the blade rotates in wrong direction, the positions of the poles in the plug have to be changed by an electrician or authorised service technician.**

## 3. Operation

### 3.1. Important notes before switching on the machine

Because of security reasons pay attention to the following notes:



- first read this operating instructions carefully
- take care that the machine is placed on a stable and secure surface
- work with concentration
- never touch the blade

### 3.2. Switch functions (push button)

red push button = main switch off

white push button = main switch on



### 3.3. Thickness of slices

The thickness of slices is infinitely variable from 0 to 10 mm. In order to adjust the thickness of the slices you have to turn the thickness knob. Turning to the left thickness plate opens. Turning to the right: thickness plate closes. The scale on the thickness knob serves as adjusting aid.



**In case the machine does not start and the tickness value on the display flashes after having pushed the "Start/Stop" key The thickness knob should be roated to a value =>0,4. Then start again.**



### 3.4. Operation of the end piece holder

Grip the end piece holder lever and pull it towards the front of the machine to disengage the drive. Then holding lever in this position, pull the lever in direction of the knife, or away from it to move the end piece holder. In order to engage the drive release the lever and move the end piece holder slightly backwards and forwards

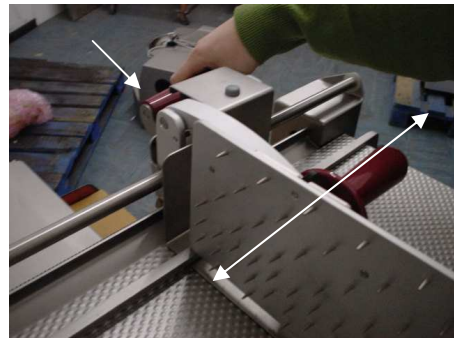

If the end piece holder is placed on top of the food product and the slicing process moves towards the knife, the machine will automatically stop approximately 40mm from the knife. This is prevent the end piece holder from hitting the sharpener cover. At this time, move the end piece holder to behind the food product and restart the machine, the machine will now slice right up to the knife, (with minimum waste)

### 3.5. Automatic or manual movement of the carriage

The machine is equipped with an automatic carriage movement which can be disengaged. The carriage can then be moved by hand.

automatic movement = lever in vertical position

movement by hand = lever in horizontal position

#### Adjusting automatic movement

Switch off the machine.

Turn lever counter clockwise to the vertical position.

Move the carriage forward and backward by hand until it is engaged.

Carriage can no longer be moved by hand now.

#### Adjusting movement by hand

Switch off the machine.

Turn the lever to the horizontal position.

Carriage can now be moved by hand.

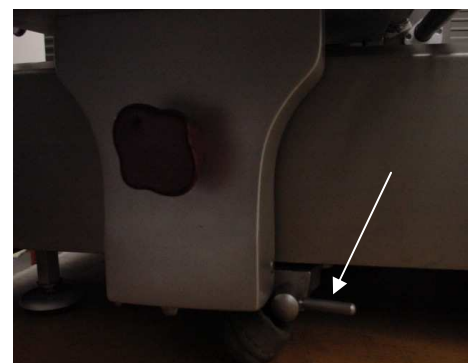

**Always switch off the machine for adjusting the carriage movement!  
NEVER ENGAGE OR DISANGAGE THE CARRIAGE WHEN THE MACHINE IS RUNNING**

### 3.6. Automatic operation

#### 3.6.1. Engaging carriage

Turn lever at the rear of the carriage counterclockwise to the vertical position. Move the carriage forward and backward by hand until it is engaged. Carriage can no longer be moved by hand.

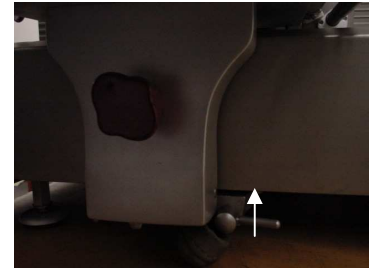

#### 3.6.2. Loading the carriage and adjusting the thickness of slices

**i** It is possible to slice 2 sausages with smaller diameters at the same time. The slices will be placed on the receiving plate side by side.

**ATTENTION!** Before loading or removing food product from the meat table, **ALWAYS** fully close the thickness plate (turn index knob to the right)

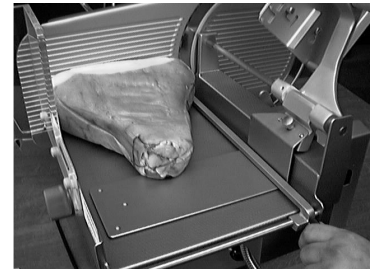

Lift up end piece holder.

Lay the food product against the front of the carriage.

Adjust the adjusting bar (fence) according to the size of the food product.

Disengage the end piece holder and adjust according to the size of the product.

Place the end piece holder upon the food product, or behind it

If the end piece holder is on top of the food product push the comb of the end piece holder into the food product.

Adjust the thickness of slices with the thickness knob (max. 10 mm).

By pushing the "end piece holder backward" key the end piece holder is moved automatically.

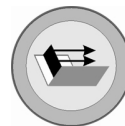

#### 3.6.3. Adjusting the speed of the carriage

Switch on the machine by pushing the white main switch.



By pushing the keys "carriage faster" or "carriage slower" you can change the speed of the carriage. The actual speed is shown on the display. You can change from MIN, 26, 27, ..., 48, 49 to MAX. If there is shown for example 35, the machine cuts about 35 slices per minute.



Pay attention to the fact that sensitive food products have to be sliced with slower speed. If the speed is too high you cannot expect good slicing results.

### 3.6.4. Notes regarding the slicing programme

You can choose the following functions per slicing procedure which will be explained in detail in chapter 4:

- Stacking of slices, choice of 1 to 4 stacks.
- Shingling of slices lengthwise, choice of 1 to 2 lines, per line several shingled portions on top of the other, adjusting the shingling distance of slices lengthwise.
- Shingling of slices crosswise, choice of 1 to 9 lines per line, several shingled portions on top of the other, adjusting the shingling distance of the slices lengthwise and crosswise.
- Circle shingling of four different diameters and several portions on top of the other.

### 3.7. Manual operation

#### 3.7.1. Disengaging carriage

Turn the lever at the rear of the carriage clockwise until horizontal position. Carriage can now be moved by hand.



#### 3.7.2. Loading the carriage and adjusting the thickness of slices

**ATTENTION! Before loading or removing food product from the meat table, ALWAYS fully close the thickness plate (turn index knob to the right)**

Lift up end piece holder.

Lay the food product against the front of the carriage.

Adjust the adjusting bar (fence) according to the size of the food product.

Disengage the end piece holder and adjust according to the size of the product.

Place the end piece holder upon the food product, or behind it

If the end piece holder is on top of the food product push the comb of the end piece holder into the food product.

Adjust the thickness of slices with the thickness knob (max. 10 mm).

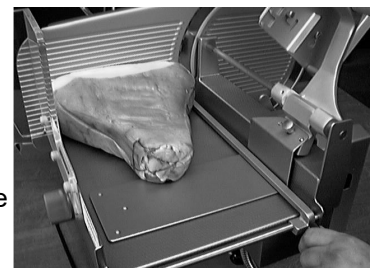

#### 3.7.3 Adjust the slicing program and start to slice

Select the required program:

- Stacking
- Shingling lengthwise
- Shingling crosswise
- Circular shingling

(See chapter 4 for more detailed information)

Move the carriage forward and backward by using the handle in front of the carriage. It is very important to push the carriage to the utmost end position in order to trigger the depositing procedure.

The machine can be stopped, or interrupted by pressing the red Stop switch

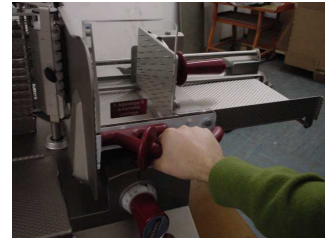

Always use the handle in order to move the carriage. The end piece holder is advanced automatically also during the manual operation of the machine, so that the food product is pushed towards the blade automatically.

- For machine with integrated sharpener:



If the end piece holder is placed on top of the food product and the slicing process moves towards the knife, the machine will automatically stop approximately 40mm from the knife. This is prevent the end piece holder from hitting the sharpener cover. At this time, move the end piece holder to behind the food product and restart the machine, the machine will now slice right up to the knife, (with minimum waste).

## 4. Slicing functions

### 4.1. Description of the keyboard





## 4.2. Starting the slicing programme

You have already put the food product into the carriage and you have adjusted the thickness of slices and the speed.



**When the machine is installed the technician adjusts the slicing programmes corresponding to your special requirements. These programmes are saved for the functions stacking, shingling lengthwise, shingling crosswise and circle shingling. The main application for the keys stacking, shingling lengthwise, shingling crosswise and circle shingling remains unchanged and is loaded after every restart of the machine.**

This way you can operate the machine easily. You can start the machine as follows:

- push the white main switch 
- then push the key "start-stop" 

Now the blade is turning and also the carriage is moving automatically if it is engaged. In case the carriage is disengaged, turn the lever (behind the carriage) until vertical, then move the carriage backwards and forwards to engage automatic mode. It is very important to push the carriage to the utmost back position in order to trigger off the depositing procedure.

**In case the machine does not start and the tickness value on the display flashes after having pushed the "Start/Stop" key The thickness knob should be roated to a value =>0,4. Then start again**

The default program is the one set by the technician during installation, the factory set default is "stacking"

In case you want to adjust another slicing programme, proceed as described in point 4.3.

## 4.3. Changing the slicing programme

To change the slicing program, first push the the key code



and after push the key of the program required.





After having select ther required program, you can change each single parameter (i.e.no. of slices, no. of rows, slice gap, etc.) moving line to line by pushing the arrow key



and set the appropriate value using nymeric keyboard.



### 4.3.1. Stacking

Push the key code  and after key "stacking" 

There is now shown on the display the preset stacking programme. It is shown graphically and in words. For example as follows:

	STACKING	: SET ACT.
	NO. OF STACK	: 1
	NO. OF SLICES	: MAX
	SPEED	: 40
	SLICES TICKNESS	:

The cursor is flashing in the line NO. OF STACK . You can now change the value.

The NO. OF STACK can be chosen by pushing the required number of stacks on the key board.

The maximum quantity is 4 stacks (two stacks each side by side and behind each other). Enter the value by pushing the key "↓" and the cursor moves to the next line.

In case you have entered 2 stacks you can choose the position of the stacks, you will see on display an additional information:

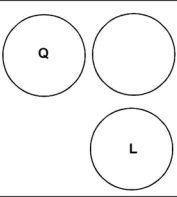
	STACKING	: SET ACT.
	NO. OF STACK	: 2
	CROSSWISE=1 DOWN =2 LENGTHWISE=2	: 1 (this line is only shown with 2 or more stacks)
	NO. OF SLICES	: MAX
	SPEED	: 40
	SLICES TICKNESS	:

either side by side (CROSSWISE: value 1) or one behind the other (LENGTHWISE: value 2). This has the following sense: In case the food product is not very high but long (for example bacon) it makes no sense to choose two stacks side by side (crosswise) as they would overlap each other. However, the receiving plate is large enough to position the stacks behind each other.

When there are sliced round food products with a calibre of maximum 90 mm there can be positioned two stacks side by side. As the stacks in the front of the receiving plate are higher than in the back there can be sliced more slices per stack.

The inquiry for positioning crosswise or lengthwise is only available when you are choosing a quantity of two stacks.

Enter your input by pushing the key "↓" and you will now be asked for the No. OF SLICES which should be sliced per stack. If you want to make use of the maximum possible height of the stack, you should enter a quantity > 99 (for example 111) and there will be shown on the display MAX after having pushed the key "↓".

 **During the slicing procedure the machine is examining continuously the adjusted thickness of slices and hereby calculates the maximum height of the stack. When the maximum height of the stack is reached the machine stops, even if the entered quantity of slices is not reached.**

When the input is terminated you can start the machine by pushing the key "start - stop".



In case the machine does not start and the tickness value on the display flashes after having pushed the "Start/Stop" key The thickness knob should be roated to a value =>0,4. Then start again



In order to avoid wrong operation during the sharpening procedure the blade will not turn when the thickness plate is opened completely and you try to start the machine by pushing the key "start – stop". (For machine with integrated sharpener)

After having started the machine, you will see on the display in the column ACT. (ACTUAL VALUE) the countdown of the total number of slices to be cut to complete the slice program.

The speed of the carriage indicated on the display can be changed at any time, also during the slicing procedure by pushing the keys "carriage faster" or "carriage slower".

The slicing procedure can be interrupted at any time by pushing the key "start - stop".

#### 4.3.2. Shingling lengthwise

Push the key code  and the key "shingling lengthwise" 

There is now shown on the display the preset shingling programme. It is shown graphically and in words. For example as follows:

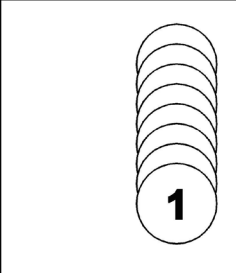
	SHINGLING DOWN	:	SET	ACT.
	LAYERS-SHINGLED	:	1	
	NO. OF SLICES	:	10	
	SLICE GAP DOWN	:	15	
	NO. OF ROWS	:	1	
	SPEED	:	40	
	SLICES TICKNESS	:		

The cursor is flashing in the line LAYERS-SHINGLED.

The number of LAYERS-SHINGLED can be chosen by pushing the required number of LAYERS-SHINGLED portions on the keyboard. The maximum quantity of LAYERS-SHINGLED (portions) is 9 (one upon the other). Enter the value and push the key "↓" to move the cursor to the next line.

You will now be asked for the NO. OF SLICES which should be sliced per single portion per line. If you enter a quantity > 99 there will be shown on the display MAX after having pushed the key "↓". The cursor moves to the next line.

Now you will be asked for the SLICE GAP DOWN .

This is the distance between the slices, i.e. if you enter for example 15, the machine cuts one slice, then the receiving plate moves 15 mm backwards and the next slice will be laid on the slice already cut with a distance of 15 mm from one edge to the other. The maximum distance is 30 mm. If you enter a value > 30 the display automatically indicates 30 mm.

 The quantity of slices is connected closely with the SLICE GAP DOWN. Larger is the distance selected in the slice gap down program and less will be the slices per line can be positioned on the receiving plate. Therefore, the machine examines if the required quantity of slices can really be positioned after you have entered the value for the distance by pushing the key "↓". In case it is not possible, the distance is automatically reduced to the maximum possible distance.

Enter the value of the SLICE GAP DOWN push the key "↓" and the cursor moves to the next line. You are now asked for the NO. OF ROWS. You have the choice of 1 or 2 lines, which can be positioned side by side on the receiving plate. To keep the lines separately one to the other the maximum diameter of the food product is 90 mm.

When the input is terminated you can start the machine by pushing the key "start - stop".



In case the machine does not start and the tickness value on the display flashes after having pushed the "Start/Stop" key The thickness knob should be roated to a value =>0,4. Then start again



In order to avoid wrong operation during the sharpening procedure the blade will not turn when the thickness plate is opened completely and you try to start the machine by pushing the key "start – stop". (For machine with integrated sharpener).

After having started the machine, you will see on the display in the column ACT. (ACTUAL VALUE) the countdown of the total number of slices to be cut to complete the slice program.

The speed of the carriage indicated on the display can be changed at any time, also during the slicing procedure by pushing the keys "carriage faster" or "carriage slower".

The slicing procedure can be interrupted at any time by pushing the key "start - stop".



### 4.3.3. Shingling crosswise

Push the key "shingling crosswise".



There is now shown on the display the preset shingling programme. It is shown graphically and in words. For example as follows:

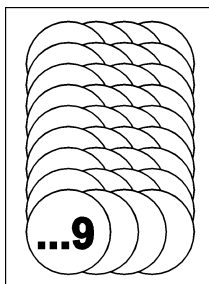

SHINGLING CROSS	:	SET	ACT.
LAYERS-SHINGLED	:	1	
NO. OF SLICES	:	10	
SLICE GAP DOWN	:	15	
NO. OF ROWS	:	4	
SLICE GAP CROSS	:	25	
SPEED	:	40	
SLICES TICKNESS	:		

The cursor is flashing in the line LAYERS-SHINGLED. You can now change the value.

The number of LAYERS-SHINGLED can be chosen by pushing the required number of LAYERS-SHINGLED portions on the keyboard. The maximum quantity of LAYERS-SHINGLED (portions) is 9 (one upon the other). Enter the value and when you push the key "↓" the cursor moves to the next line

You will now be asked for the NO. OF SLICES which should be sliced per single portion per line. If you enter a quantity > 99 there will be shown on the display MAX after having pushed the key "↓". The cursor moves to the next line.

Now you will be asked for the SLICE GAP DOWN.

This is the distance between the slices, i.e. if you enter for example 15, the machine cuts one slice, then the receiving plate moves 15 mm backwards and the next slice will be laid on the slice already cut with a distance of 15 mm from one edge to the other. The maximum distance is 30 mm. If you enter a value > 30 the display automatically indicates 30 mm.

**i** The quantity of slices is connected closely with the SLICE GAP DOWN. larger is the distance selected in the slice gap down program and less will be the slices per line can be positioned on the receiving plate. Therefore, the machine examines if the required quantity of slices can really be positioned after you have entered the value for the distance by pushing the key ↓. In case it is not possible, the distance is automatically reduced to the maximum possible distance.

Enter the value of the SLICE GAP DOWN push the key "↓" and the cursor moves to the next line. You are now asked for the NO. OF ROWS. You have the choice of 1 up to 9 lines, which can be positioned side by side on the receiving plate (in lengthwise direction).

These lines are shingled lengthwise as well as in crosswise direction. The distance for crosswise shingling will be adjusted in the SLICE GAP CROSS line.

Enter the value and when you push the key "↓" the cursor moves to the next line

You will now be asked for the SLICE GAP CROSS.

This is the distance (max. 50 mm) between the slices positioned side by side. If you enter for example 15, the machine positions the second slice with a distance of 15 mm next to the first one. In case the last line gets beyond the receiving plate you either have to reduce the distance crosswise or the quantity of lines.



The quantity of slices is connected closely with the SLICE GAP CROSS. Larger is the distance selected in the slice gap cross program and less will be the numbers of rows which can be positioned on the receiving plate. Therefore, the machine examines if the required quantity of slices can really be positioned after you have entered the value for the distance by pushing the key "↓". In case it is not possible, the distance is automatically reduced to the maximum possible distance.



When the input is terminated you can start the machine by pushing the key "start - stop".

**In case the machine does not start and the tickness value on the display flashes after having pushed the "Start/Stop" key The thickness knob should be roated to a value =>0,4. Then start again**

In order to avoid wrong operation during the sharpening procedure the blade will not turn when the thickness plate is opened completely and you try to start the machine by pushing the key "start – stop". (For machine with integrated sharpener).

After having started the machine, you will see on the display in the column ACT. (ACTUAL VALUE) the countdown of the total number of slices to be cut to complete the slice program.

The speed of the carriage indicated on the display can be changed at any time, also during the slicing procedure by pushing the keys "carriage faster" or "carriage slower".

The slicing procedure can be interrupted at any time by pushing the key "start - stop"



#### 4.3.4. Circle shingling

Push the key "circle shingling".



There is now shown on the display the preset circle shingling programme. It is shown graphically and in words. For example as follows:

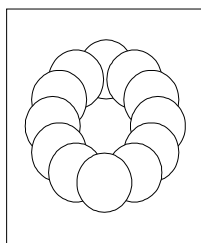

DEPOSIT CIRCLE				
LAYERS-SHINGLED	:	1		
NO. OF SLICES	:	10		
SAUSAGE DIAMETER	:	100	mm	
CIRCLE DIAMETER	:	200	mm	
SPEED	:	30		
SLICES TICKNESS	:			

The cursor is flashing in the line LAYERS-SHINGLED. You can now change the value.

The number of LAYERS-SHINGLED can be chosen by pushing the required number of LAYERS-SHINGLED portions on the keyboard. The maximum quantity of LAYERS-SHINGLED (portions) is 9 (one upon the other). Enter the value and when you push the key "↓" the cursor moves to the next line.

You will now be asked for the NO. OF SLICES which should be sliced per circle. The maximum quantity of slices is 60. Confirm the entered value by pushing the key "↓". The cursor moves to the next line.

Now you will be asked for the SAUSAGE DIAMETER. You have to indicate the diameter as exact as possible. This value takes influence on the shape of the circle. Confirm the entered value by pushing the key "↓". The cursor moves to the next line.

Now you will be asked for the CIRCLE DIAMETER. Generally can be entered a maximum diameter of 230 mm. The machine examines if the required diameter can really be positioned after you have entered the value. In case it is not possible, the value is automatically calculated to the possible diameter. Larger is the diameter of the food product and less will be the numbers of slices deposited in one circle.

It also makes no sense to choose the smallest diameter and 20 slices per circle as then the result would rather be a "tower" and not a circle

For testing you should take a food product with a diameter of about 80 to 90 mm. Then you should cut a circle with a diameter of 230 mm with 20 slices, then cut a circle with a diameter of 190 mm with 10 slices, afterwards a circle with a diameter of 140 mm with 8 slices and finally a circle with a diameter of 100 mm with 6 slices. All circles are positioned accurately on top of each other as the centre of each circle is always the centre of the receiving plate.

When the input is terminated you can start the machine by pushing the key "start - stop".



**In case the machine does not start and the thickness value on the display flashes after having pushed the "Start/Stop" key The thickness knob should be rotated to a value =>0,4. Then start again**

In order to avoid wrong operation during the sharpening procedure the blade will not turn when the thickness plate is opened completely and you try to start the machine by pushing the key "start – stop". (For machine with integrated sharpener).

After having started the machine, you will see on the display in the column ACT. (ACTUAL VALUE) the countdown of the total number of slices to be cut to complete the slice program.

The speed of the carriage indicated on the display can be changed at any time, also during the slicing procedure by pushing the keys "carriage faster" or "carriage slower".

The slicing procedure can be interrupted at any time by pushing the key "start - stop".



## 5. Programmed Operation (PLU)

Within the so called PLU-Mode you can programme for certain articles all necessary slicing data and call them up at any time. There can be programmed 99 different PLU-Numbers with maximum 3 digits each one.

With every PLU-Number there are programmed all necessary slicing data, such as: name of the article, diameter of the food product, speed of the carriage, thickness of slices and all parameter for stacking, shingling lengthwise, shingling crosswise or circle shingling.

### 5.1. Choosing PLU-Number

After having started the machine by pushing the white main switch the machine is within the manual mode and can be operated as described before. To change to the PLU-Mode press the PLU key once. Then will be shown on the display `PLU - MODE`. By pushing the key PLU again the machine returns to the manual mode. Within the PLU-Mode the display looks like follows:

```

                                PLU – MODE
Choose article      : ....
No. portions       :
.....
                                SET  ACT.
Thickness of slices :      ....   ....   mm
```

Now you can enter the PLU-Number. In case you have saved a PLU-Number with 1 digit, there will be shown an article programmed under this number after having entered the first digit. If you continue entering a second or third digit, the programmed article with PLU-Number consisting of 2 or 3 digits will be shown on the display accordingly. When entering a fourth digit the complete number will be moved to the left with the result that the first digit will be lost and the fourth digit will be on the third position now.

#### Example:

On the display there is indicated PLU-Number '602'. If now a further digit is entered, for example '4', there will be shown on the display the PLU-Number '024'.

In case you are entering a PLU-Number without programmed slicing data, there will be shown on the display `PLU NOT PROGRAMMED`. As soon as there is entered a programmed PLU-Number there will be shown on the display the name of the article, for example "cooked ham".

In case there is already shown an article on the display, you can scroll up and down with the keys <↑> and <↓>. The PLU-Numbers are indicated in chronological order.

When you have found the correct PLU-Number you have to confirm by pushing the key "start-stop" and the machine will run.



Please take note if you have a machine with conveyor belt (937 slicer) the machine will ask for the number of portions to be sliced.

There is meant the total number of needed portions of one PLU-Number. If you have to cut for example 20 portions you have to enter 20. After these 20 portions have been cut the machine stops automatically.

On the display there is shown the countdown of the portions which have still to be cut. Even if the slicing procedure is interrupted the machine keeps in its memory the portions which still have to be cut. The countdown will be continued after the restart of the machine. In case you do not want to continue the portions of the chosen PLU-Number you can just enter a new PLU-Number and the previous number or portions is deleted.

After having entered the number of portions the machine can be started by pushing the key "start-stop" without effecting further adjustments.

However, you have to see that the programmed thickness of slices is adjusted with the thickness knob before. In case it has not been done, the actual value in the line THICKNESS OF SLICES is flashing. It stops flashing when the correct thickness of slices has been adjusted.

Now you can start the machine by pushing the key "start-stop" again.

In case the food product is sliced up during the production of one portion the machine stops and the end piece holder moves backwards automatically. After having reloaded the carriage with a new food product the uncomplete portion will be terminated when pushing the key "start-stop".

If you do not want the machine to continue where it stopped before you can cancel this function by pushing the key "C".

In case you want to modify the programmed parameters of a certain article for a short time and you do not want to save these modifications, you can modify the values by pushing the key <#> when the cursor is flashing on PLU number. You can then select all parameters of this certain article for modification by pushing the keys "↓" and "↑".

Regarding meaning and data input of the parameters see chapter "Data conditioning". When the input is terminated you can start the machine by pushing the key "start - stop". The modifications can be undone at any time by pushing the key .

The above described modification of parameters of a certain article is only temporary and is not permanently saved within the programmed PLU-Number. When choosing this certain article again the originally programmed data are indicated. Concerning permanent modification see chapter "Data conditioning".

In case you are pushing the key "start-stop" without having chosen a valid PLU-Number there is again shown on the display `PLU NOT PROGRAMMED`

## 5.2. Data conditioning

In order to call the function **DATA CONDITIONING** you have to push within the PLU-Mode the following key combination **<CODE> <1> <\*>**

On the display there will be shown the main menu for choosing several functions

PLU - DATA CONDITIONING

CREATE ARTICLE YES=1\*

COPY ARTICLE YES=2\*

DELETE ARTICLE YES=3\*

MODIFY ARTICLE YES=4\*

FUNCTION <CODE>

**Cursor is flashing here**

By pushing the keys 1 (2, 3, 4) and \* you can choose the required function.

You can leave the menu by pushing the key CODE.



### 5.2.1. Create article and modify data

After having pushed 1\* within the menu data conditioning there will be shown on the display:

```
**** CREATE ARTICLE ****
PLU-NUMBER :      001      Cursor is flashing
```

If you want to exit from menu push the CODE key.



#### Now you have to enter the new PLU-Number.

In case the PLU-Number already exists there will be shown on the display the name of an article already programmed. If not, there will be shown 'PLU NOT PROGRAMMED'. A PLU-Number already programmed cannot be created again. In case an existing number should be used for another article, this number has to be deleted first → DELETE ARTICLE. After having done so you can create a new article within this menu. After having entered the new PLU-Number confirm by pushing the key "↓" and the cursor is moved to the next line.

#### Now you will be asked for the diameter of the food product.

Enter the value in millimetres. For rectangular food products you have to enter the cutting length in millimetres. Enter your input by pushing the key "↓" and you will get to the next line.

#### In this line you have to enter the name of the article.

You have to enter the single letters by using the supplied film (see illustration on the right) which has to be laid upon the keyboard. Now push the corresponding keys for entering the name of the new article.

Entering special letters:

The letters A, O, U and E are configured that way that special letters can be entered, too. The special letters can be called up by pushing the key for the required letter a longer time. The letters are displayed in the following order:

A→Ä→Å, O→Ö, U→Ü, E→É

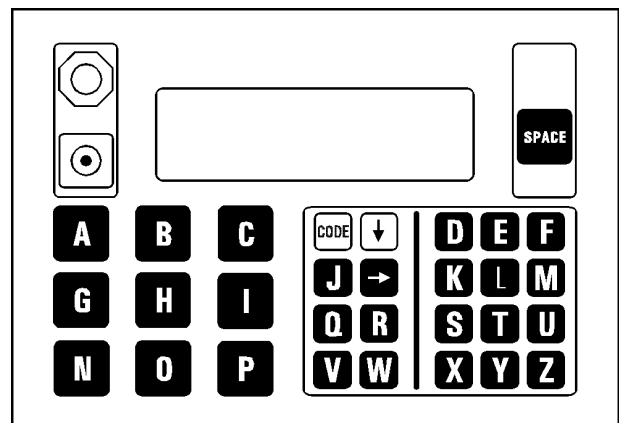

After having entered all letters confirm your input by pushing the key "↓", the film can be taken away now and the keys have their original function again. The cursor is moved to the next line.

#### In this line you have to enter the speed of the carriage.

By pushing the keys "carriage faster" or "carriage slower" you can change the speed of the carriage. The actual speed is shown on the display. You can change from MIN, 26, 27, ..., 48, 49 to MAX.



After having entered all letters confirm your input by pushing the key “↓”. The the cursor is moved to the next line.

Now you have to set **the slice thickness**.

Put the value that you want using the numeric keyboard. After having entered the required value, confirm your input by pushing the key “↓”.

The display now shows the cutting programs that we have already described at the chapter 4 – SLICING FUNCTIONS (stacking, shingling lengthwise, shingling crosswise, circle shingling).

By pushing the keys "stacking", "shingling lengthwise" , "shingling crosswise" or "circle shingling" you can enter the required slicing data.

When the complete input for the new article has been terminated, all data are saved by pushing the key

"start-stop". 

 To exit from the procedure without save any data, you can push, at any time, the CODE key and all setting values regarding this new article will not be stored.



### 5.2.2. Copy article

In order to create quickly a new PLU-Number for a similar article, you can use the copy function.

With this function you can copy all slicing data of an existing article for another article. In case this other article does not yet exist it will be created by copying.

After having pushed 2\* within the menu data conditioning there will be shown on the display:

```
**** COPY ARTICLE ****
OLD PLU NUMBER   :   Cursor is flashing
NEW PLU NUMBER   :
```

Enter the old PLU-Number. In case this PLU-Number does not exist, there will be shown on the display PLU NOT PROGRAMMED. If it is available there will be shown the name of the article programmed with this PLU-Number. When the correct article has been chosen confirm by pushing the key “↓”.

Now enter the new PLU-Number to which the slicing data of the old PLU-Number shall be copied.

The new number must be free. It is not possible to copy the slicing data to a PLU-Number which is existing already.

The new number is confirmed by pushing the key “↓” and will then be copied.

You can interrupt this procedure by pushing the key CODE at any time.



### 5.2.3. Delete article

With the function delete article you can delete an existing PLU-Number including all slicing data for a certain article.

After having pushed 3\* within the menu data conditioning there will be shown on the display:

```
**** DELETE ARTICLE ****
PLU-NUMBER       :   Cursor is flashing
```

Enter the PLU-Number you want to delete. In case this PLU-Number does not exist, there will be shown on the display PLU NOT PROGRAMMED.

If it is available there will be shown the name of the article programmed with this PLU-Number. When the correct article has been chosen confirm by pushing the key "↓" and the cursor moves to the next line.

In this line there is indicated "DELETE 1 = yes 0 = no :". The cursor is flashing behind the double point.

The PLU-Number is only deleted when entering "1" and confirming by pushing the key "↓". The PLU-Number you deleted can now be used again for other articles.

You can interrupt this procedure by pushing the CODE key at any time.



#### 5.2.4. Modify article

With this function you can modify single parameters within an existing PLU-Number.

After having pushed 4\* within the menu data conditioning there will be shown on the display:

\*\*\*\* MODIFY ARTICLE \*\*\*\*

PLU NUMBER :                      **Cursor is flashing**

Enter the PLU-Number of the article where you want to modify certain parameters.

In case this PLU-Number does not exist, there will be shown on the display PLU NOT PROGRAMMED. If it is available there will be shown the name of the article programmed with this PLU-Number. Confirm the PLU-Number by pushing the key "↓".

Now you have to proceed in the same way as described in chapter 5.2.1 → create article. All programmed values can be modified by overwriting.

The modified values are saved by pushing the key "start-stop",



see chapter 5.2.1 → create article.

You can interrupt this procedure by pushing the CODE key at any time.



## 6. Slicing of end pieces

Special notes regarding slicing of end pieces of food products:

Before placing the remaining piece of the food product in the carriage you have to cut off the pointed end. Otherwise the food product cannot be held correctly by the end piece holder

Move the end piece holder backwards as far as it will go,

either by pushing the key "end piece holder backward"



or by moving the end piece holder by hand.

Lay the food product against the front of the carriage.

Adjust the adjusting bar (fence) according to the size of the food product.

Disengage the end piece holder and push it by hand behind the food product, until the food product is in close contact to the thickness plate.

Adjust the thickness of slices with the thickness knob (max. 10 mm)



**Never try to hold the food product by hand, this could cause serious injury.**

**Always use the end piece holder.**

**Never try to load the carriage while it is moving automatically. Always switch off the machine first and close the thickness plate before loading or unloading product, otherwise you risk injury!**



## 7. Cleaning

Before initial operation and after a long period of the machine standing still the machine has to be cleaned carefully.

With permanent use of the machine you have to clean it **at least one per day** or if necessary a few times per day.



**Risk of getting hurt!**

**Be careful when cleaning the machine especially in the area of the knife there is a risk of injury. Always work with concentration, do not let yourself become distracted from your work.**

### 7.1. Taking off parts of carriage

Switch off the machine!

Pull out the plug!

Close the thickness plate completely by turning the thickness knob to the right.



Lift up the end piece holder.



Loosen the knurled knob on the end piece holder comb and take the comb off.



Loosen the knurled knob of the end piece holder plate and take the plate off.



Loosen the knurled knob on the adjustable bar and lift it up.



Take off the feed plate by pulling it upwards  
(the end piece holder has to be lifted up before doing this).



Now all removable parts of the carriage have been taken off.

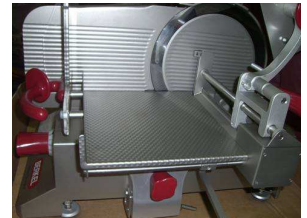

Place the adjustable bar and the end piece holder back into their original position



Disengage the carriage for adjusting its manual movement of the carriage  
(see the position of the lever in picture) and pull the carriage to the front of the machine

automatic movement (carriage engaged) = lever in upright position  
movement by hand (carriage disengaged) = lever in horizontal position



Loosen the star knob on the carriage by turning it to the left until completely loosened .

Tilt the carriage aside.



- The carriage cannot be tilted aside if:
- the thickness plate is still opened
  - the carriage has not been disengaged to manual movement.

**Always tilt the carriage with care, do not use force!**



### 7.2. Taking off the blade guard

Loosen the knurled knob behind the motor housing and hold the blade guard with the other hand. By pushing against the knurled knob, the blade guard is pushed out against your hand and you can then take the blade guard off.



### 7.3. Taking off stacking device and chain frame

Loosen the red star knob on the stacking device and take off the stacking device away from the machine.

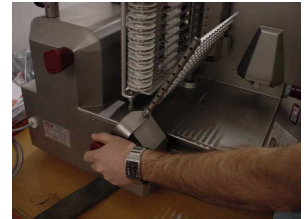

Lift up the chain frame



**Always lay down the chain frame on an even flat ground, otherwise there is a risk that the needles of the chains can bend or break off**



### 7.4. Taking off deflector and receiving plate

Take off the deflector comb by unlocking the knob



Take off the receiving plate by lifting it upwards.



Now you can proceed to cleaning the parts as shown below using a brush, warm water with detergent acid and chlorine free.

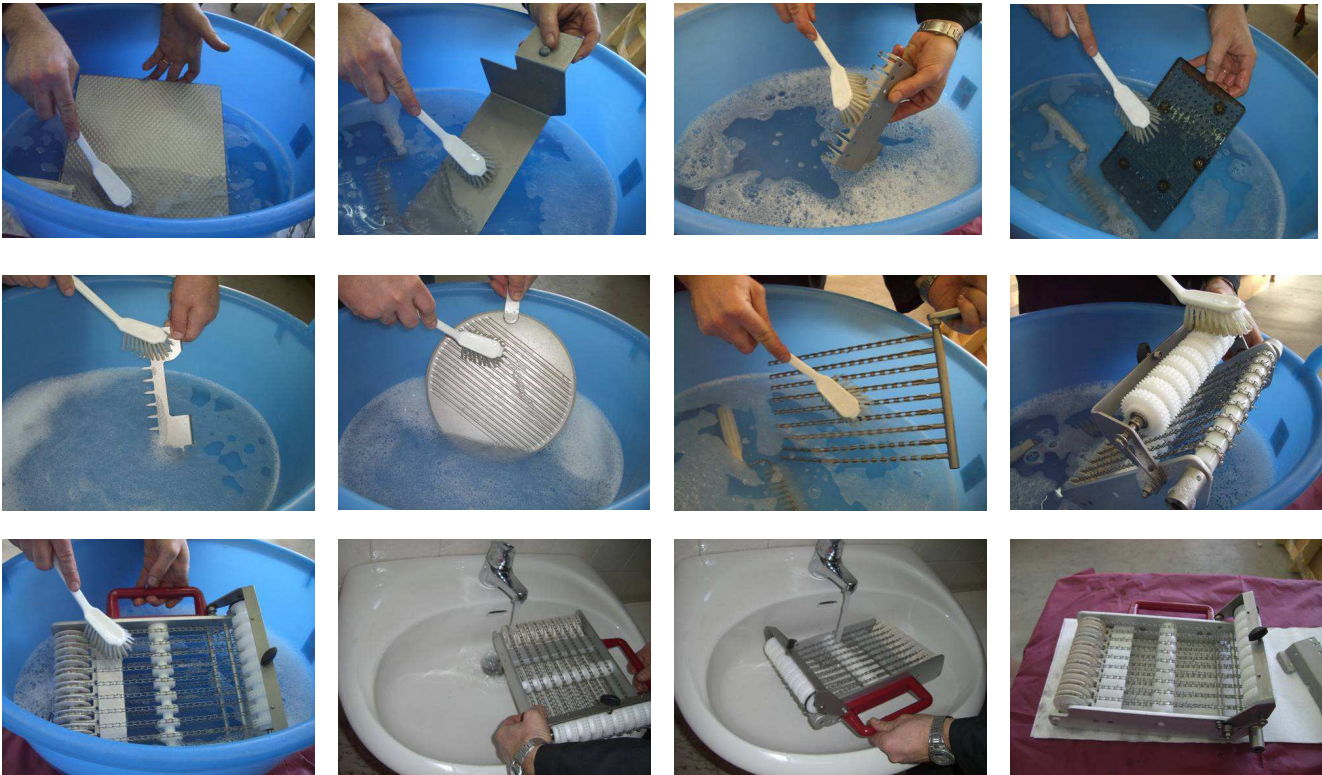

Now you can wash up each single part with clear water and dry them using a cloth.

### 7.5. Cleaning the blade

**Attention! Risk of getting hurt!**



cleaning process

Make sure that the thickness plate is closed completely and the machine is switched to manual movement (3.4). Always clean the front of the knife, from the centre outwards. Always use the knife remover provided to remove the knife during the knife

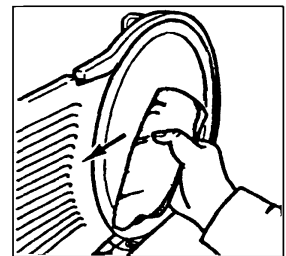

#### 7.5.1 Cleaning the front of the knife

Move the meat table to the back of the machine. Clean the front of the knife, using a cloth. Clean from the centre outwards

#### 7.5.2 Removing and cleaning the knife

Lift the sharpener cover (if fitted) upward, away from the knife. Fit the remover to the front of the knife by engaging the two fixing star knob screws. Ensure that the two star screws are fully tightened. Unlock and remove the knife fixing screws in the centre of the knife. Lift the remover and attached knife away from the machine, using the star knobs as handles.



Carefully by eye inspect around the edge of the knife to ensure that the knife is fully covered by the remover before proceeding. If it is not covered then refit onto machine and call the authorised dealer

Put the remover with the knife attached onto a stable flat surface, with the remover closest to the surface. Clean the rear of the knife, using a cloth always from the centre of the knife outwards. Lightley oil the flat surface of the rear of the knife that fits to the slicers knife drive.

### 7.5.3 Clean the inside of the knife ring guard

Whilst the knife is removed, using a cloth clean around (inside and out) the knife ring guard

### 7.5.4 Refit the knife

Refit the knife in the reverse sequence of removal

### 7.6. Cleaning the single parts

Cleaning	Detergent	Procedure	Cleaning device	Procedure after cleaning
machine	warm water, detergent, free from acid from chlorine	manually	cleaning cloth, cleaning brush	wash with clear water, dry
machine with tefloned parts	warm water, detergent, free from acid from chlorine	manually	cleaning cloth, cleaning brush	wash with clear water, dry <b>dry tefloned parts very carefully</b>
detached parts	warm water, detergent, free from acid from chlorine	manually	cleaning cloth, cleaning brush	wash with clear water, dry
blade	warm water, detergent, free from acid from chlorine	manually	cleaning cloth or sponge	wash with clear water, dry
sharpening stones	warm water, detergent, free from acid from chlorine	manually	cleaning brush	degrease with degreasing agent (spirit or similar)



For cleaning only use mild washing-up detergent. Do not use cleansing agents or devices that will scratch the machine.



**The machine is only drip-proof!**  
Therefore do not use high pressure cleaning devices, water hoses or similar devices. Furthermore you must not pour water over the machine. Danger of short circuit or machine defect. In such cases any claims regarding warranty will be refused.

## 7.7. Reassembling the parts

Reassemble the parts in reverse order. (7.4. → 7.1).

**Attention! Risk of getting hurt!**

## 8. Sharpening the blade

In case the cutting result should no longer be satisfactory or the food products are getting "beards", the blade has to be sharpened.

There cannot be indicated certain intervals for sharpening as it depends on how frequently the machine is used.



**Pay attention to the fact that the blade has to be exchanged if the gap between blade edge and the fixed protecting ring is more than 5 mm.**

**According to European regulations further sharpening of the blade it is not allowed when the gap is more than 5 mm.**

### 8.1. Sharpening device



**Only the sharpening assembly may be used for sharpening.**

**Usage of other sharpening devices can cause serious injuries or damage the machine. Never use another sharpening device.**

The sharpening device is equipped with 1 stone for sharpening and 1 stone for taking off the burr.

Never use the sharpening device on an uncleaned machine as the stones will then lose their efficiency. In case this should happen, clean the stones carefully with washing liquid and a brush.

### 8.2. Using the sharpening device



**Important! Adjust the machine to manual carriage movement (see chapter 3.4.)**

**Take off all removable parts (see chapter 7.4.)**

Clean the machine carefully, as described in chapter 7.

Never sharpen a knife that has not been cleaned

Turn the carriage back. Tighten the star knob of the carriage.

With the thickness plate fully closed put a beer mat or similar on to the carriage. Now open the thickness plate and MANUALLY cut a few strips off the mat. Close the thickness plate

(This way the fat will be totally removed from the blade edge)

Check again if the machine is in manual.

Pull the carriage completely to the front.

Remove the beer mat or paper felt.

**Attention! Risk of getting hurt!**

**Close the thickness plate**

### 8.3. Sharpening the blade (with integral sharpener)

- In order to avoid an incorrect operation during the sharpening procedure the blade will not turn when the thickness plate is open and you try to start the machine by pushing the key "start-stop".
- Only when the thickness plate is closed completely, the blade will start to turn after having pushed the "sharpening" key"
- Open the cover of the sharpener, loosen the handle grip and turn through 180° the sharpening device. Then tighten the handle grip.
- Sharpen with light pressure the blade for approximately 10 seconds, by pushing only the sharpener stone (the stone on the back of the blade..)
- Push again the "sharpening" key for stopping the machine
- Wait until the blade has stopped turning.
- Visually check if there has been built a visible burr at the edge of the blade.
- If not: Sharpen again.
- Switch on the machine again by pushing the "sharpening" key
- For taking off the burr, push the front de-burring stone for about 3-4 seconds.

### 8.4. Repositioning of the sharpener

- Push again the "sharpening" key to stop the machine.
- Loose the handle grip of the sharpener
- Turn the sharpener through 180°, to its rest position
- Close the sharpener cover.

Now fully clean the machine of the swarf from the stones.



**Attention! Risk of getting hurt!**

**Always work with concentration, do not allow yourself to get distracted**

**Never check the sharpness of the blade with your fingers.**

**For the slicers that use the removable sharpening device follow the instructions below:**

### 8.5 Mounting the removable sharpening device

- Position the carriage in the centre.
  - Lift up end piece holder
  - Open the thickness plate completely.
  - Ensure the pointer on the sharpener is adjusted to position "0" by using the yellow hand wheel. Mount the sharpening device on to the thickness plate so that the fixed bottom pin of the sharpening device fits into the slot on the bottom of the thickness plate (direction of arrow)
- 
- Pull out the pin on top of the sharpening device in direction of arrow and move the sharpening device over the edge of the thickness plate.

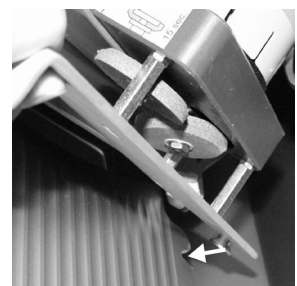

- Move the sharpening device with the pin pulled out to the front in the direction of the blade (direction of arrow), so that the pin is engaged in the hole of the thickness plate.

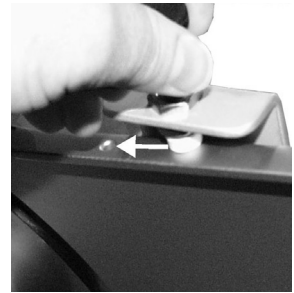

- The sharpening stones are now in the correct position, i.e. the blade edge is positioned between the two sharpening stones.

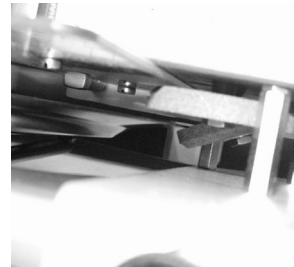

### 8.6 Sharpening the blade

- Switch on the machine
- Turn the yellow handwheel of the sharpening device in direction 1. By means of this the sharpening stone sharpening the blade is pushed towards the blade.
- Approximately 10 seconds are enough.
- Switch off the machine
- check if there has been built a visible burr at the edge of the blade
- If not: Sharpen again
- Switch on the machine again
- For taking off the burr turn the yellow handwheel in direction 2. Now both sharpening stones are touching the blade.
- Approximately 3-4 seconds are enough to take off the burr.
- When the sharpening procedure is complete turn the yellow handwheel to 0.

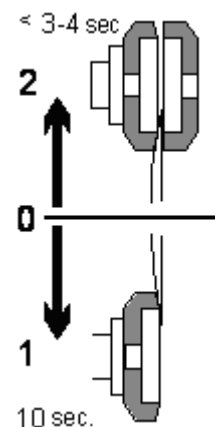

### 8.7 Remove the removable sharpening device

- Switch off the machine.
- Pull the pin on top of the sharpening device upright in direction of arrow.
- Tilt the sharpening device aside to the right.
- Remove the sharpening device.

Now fully clean the machine of the swarf from the stones.



**Attention! Risk of getting hurt!**  
**Always work with concentration, do not allow yourself to get distracted**  
**Never check the sharpness of the blade with your fingers.**

- **Close the thickness plate**



## 9. Maintenance

Clean the machine at least once a day

If necessary sharpen the blade, (at least once a day, depending upon usage)

In case the gap between blade edge and fixed protecting ring is more than 5 mm the blade has to be exchanged, (always use the knife remover provided to do this, see chapter 6.5.2 for safe removal)

If necessary the sharpening stones have to be cleaned or exchanged.

NOTE: if the knife is exchanged, the stones should also be exchanged



**Lubrication must be done by only using acid free and resin-free oil!**

### Oiling points:

For lubricating only use acid free oil

Slide bar of end piece holder (every day after cleaning)

Slide bar of carriage (as required)

Slide bar of receiving tray (everyday after cleaning)

### 9.1. Lubrication of sliding bars – end piece holder and receiving tray

As the machine has to be cleaned every day, mostly the slide bars become dry. In this case the driving motors need more power to move the end piece holder or the receiving tray. For this reason it is very important to lubricate these two sliding bars regularly.

For lubricating the sliding bars use acid and resinous oil free (the best solution is Klüber Syntheso D 1000 Syntheso D 1000 EP). Even better is the lubricant that Berkel uses in the factory (Klüber Isoflex Topas NB 5051).

After having lubricated the slide bars, move the end piece holder and the receiving tray backward and forward by hand to get the lubricant into the bearings.

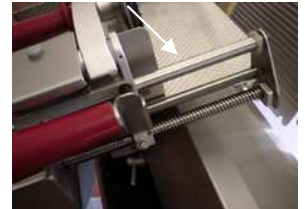

### 9.2. Lubrication of stacking device and blade protection

Remove the stacking device and lubricate the thread as well as the threaded bush with water-resistant grease (in the factory Berkel uses Autol Top 2000). Refit the stacking device. You should also check the correct position and tightness of the chaine frame and the deflector behind the blade.

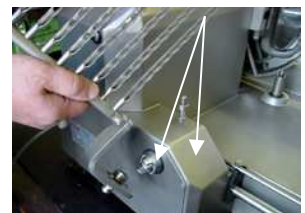

Remove the blade protection and lubricate the threaded bush, the hole of the knife hub and the thread of the fixing screw for the blade protection (in the factory Berkel uses Autol Top 2000).



Lubricate the thread of the star knob on the carriage (in the factory Berkel uses Autol Top 2000).



### 9.3. Lubrication of adjusting bar (fence) on the carriage and the roller deflector bearing

Lubricate the slide bar of the adjusting bar on the carriage (Berkel use Klüber Isoflex Topas NB 5051). Check if the adjusting bar can be adjusted easily by moving it several times backward and forward (if not, then lubricate slide bar)

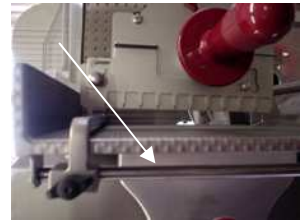

Put some drops of oil on each roller deflector bearing two, three times per week



## 10. Trouble shooting

### Problem

### Solution

#### **Grinding noise**

blade guard has not been mounted correctly loosen blade guard, mount it again and fix it as described in point 7.2

blade guard is dirty clean as described in chapter 7.4

deflector finger touches the blade adjust deflector fingers with hexagon socket screws

#### **Guide roll is jumping**

needles of the chain are bent take off the chain frame as described in point 7.3, straighten the needles with a flat nose plier

#### **Stacking device touches chain frame**

stacking device is bent take off the stacking device as described in point 7.3, straighten the fingers of the stacking device

#### **Metallic sound**

star knob of the stacking device is loose fasten the star knob

#### **Slice gets caught by the deflector**

distance between deflector and blade is too large adjust deflector with hexagon socket screws

#### **Machine stops automatically**

short-term voltage drop, switch on the machine again

#### **Automatic carriage movement does not work**

error message on the display "carriage not engaged" engage the carriage as described in point 3.4.

"Fuse" is shown on the display. Fuse for automatic carriage movement is activated. Wait 5 minutes.

#### **Display is not illuminated**

fuse for electronic control is activated. Wait 5 minutes.

#### **Machine is getting warm**

wall socket and plug have to be checked by an electrician.

#### **Sausage skin tears or stacks are irregular**

sharpen the blade and take off burr

#### **The slices don't come-out**

Check the correct position of the slices deflector (must be closely to the blade)

**The machine is equipped with automatic fuses. In case there are any misfunctions on the machine during operation proceed as follows. Switch off the machine at the main switch. Wait for about 5 minutes and start the machine again. Only if the misfunction occurs again ask for after sales service for checking.**

### 10.1. Error messages on the display

#### **“Make service“**

The machine has cut more than 750.000 slices. It is necessary to effect general maintenance on the machine. Inform your after sales service. By pushing again the key "Start Stop" the machine starts as usual.

## 11. Waste disposal



The symbol of bins crossed reported to the equipment or its packaging indicates that the product at the end of its useful life should be collected separately from other waste.

The collection of this equipment arrived at the end of life is organized and managed by the manufacturer. If you want to get rid of this equipment will then contact the manufacturer and follow the system that this has adopted to allow the separate collection of the junta at the end of life.

The improper disposal of the product by the keeper includes the application of administrative sanctions provided for by current legislation

# Instructions for 937 version

## 12. Dimensions and description of the machine

### 12.1. Dimensions of the machine and technical data (only for 937 version)

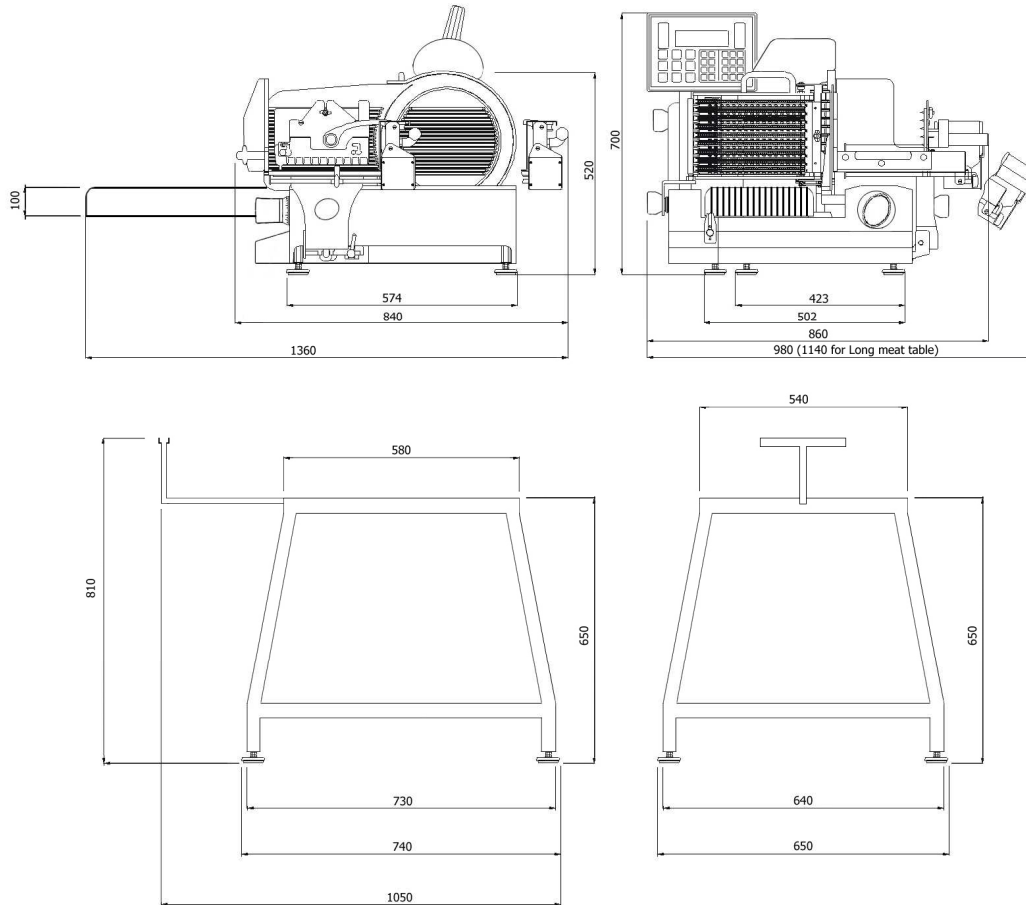

Overall dimensions	( 1360x980x1350h mm <u>standard table</u> ) and ( 840x1140x1350h mm <u>long meat table</u> )
Foot distance	574x502 mm
Max. cutting size	ca. 255x195h mm
Thickness of slices	0 - 10 mm (infinitely variable)
Diameter of blade	330 mm
Sound level	< 54 db(A)
Weight	about 96 kg (without stand)
Voltage and cycles	see rating plate
Power	0,9 kW

## 12.2. Description of the machine

The description of the 937 is the same as the 936, except the 937 has an integrated conveyor and table / stand

The programming of the 937 is the same as the 936, except the 937 has an extra program which sets "portioning". This allows a stack or shingle to be repeated. The conveyor automatically moves as each portion (repeat program) is completed, carrying the portion along the conveyor, allowing room for the next portion. This is repeated as many times as programmed.

There is a safety switch on the end of the conveyor, this stops the machine when a portion reaches it, therefore stopping the food product from falling onto the floor. The portion can be taken off the conveyor, (away from the switch) and the machine restarted.

## 12.3. General plan of the machine

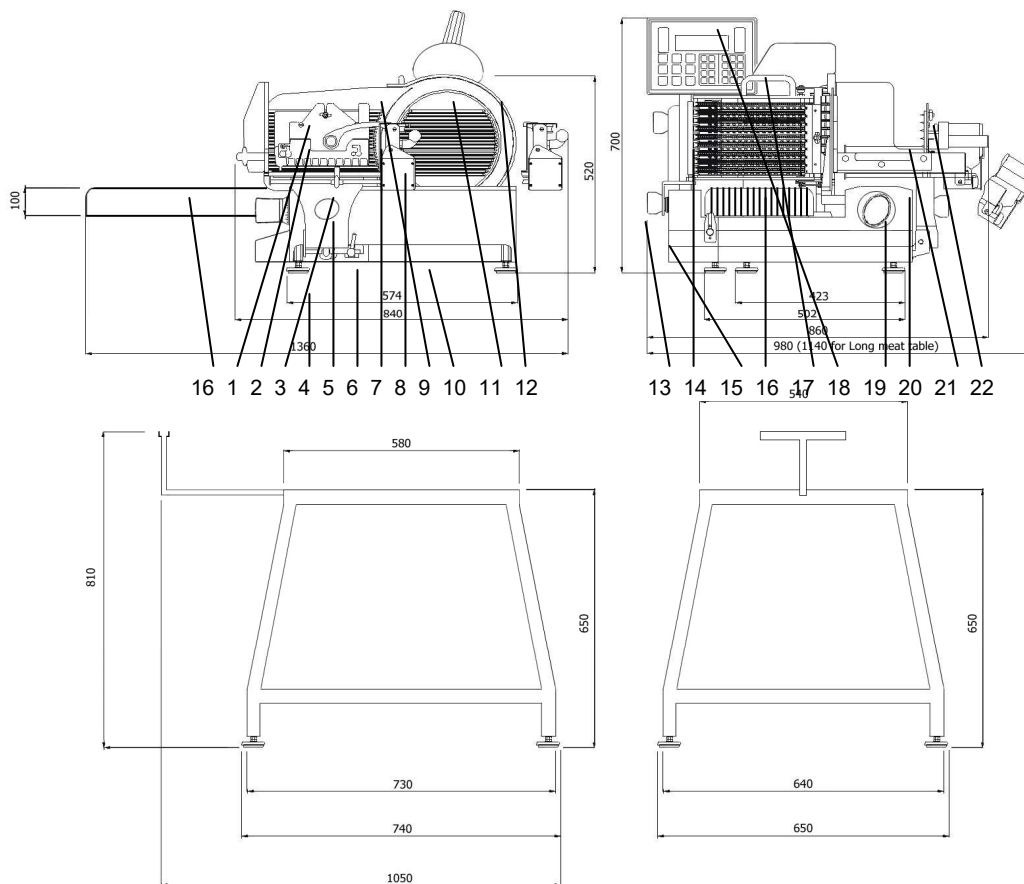

- |                          |                              |                                   |
|--------------------------|------------------------------|-----------------------------------|
| 1 End piece holder       | 10 Guiding axle carriage     | 19 Hand protection                |
| 2 Comb, end piece holder | 11 Blade guard               | 20 Thickness knob                 |
| 3 Adjusting bar          | 12 Fixed ring                | 21 Guiding axle, end piece holder |
| 4 Rubber foot            | 13 Star knob stacking device | 22 Plate of end piece holder      |
| 5 Star knob for carriage | 14 Stacking device           |                                   |
| 6 Lever                  | 15 Rating plate              |                                   |
| 7 Carriage feed plate    | 16 Conveyor belt             |                                   |
| 8 Carriage               | 17 Chain frame               |                                   |
| 9 Thickness plate        | 18 Display and keyboard      |                                   |

## 12.4. Usage

As 936

## 12.5. Installation and initial operation



**First read these operating instructions carefully. They are only valid in combination with the operating instructions of model 936. These additional instructions are only a supplement. Take care of all given hints.**

Only operate the machine according to the instructions.  
Always work with care and concentration, this helps to avoid personnel injury and damage to the machine  
The installation, introduction and initial operation have to be done by an authorized supplier or service technician.

## 12.6. Installation



**Install the food slicer model 937 on the supplied table. See to it that the feet of the machine are placed into the holdings fixed on the table.**

Place the conveyor belt upon the machine and push it towards the chain frame, (in 3 positions)

Pay attention that the conveyor belt is fixed correctly to the fixings (as in photographs below) of machine body and table.

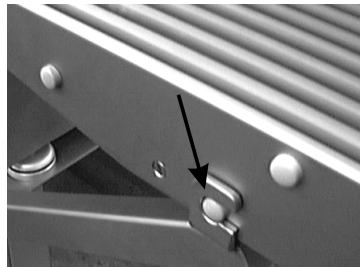
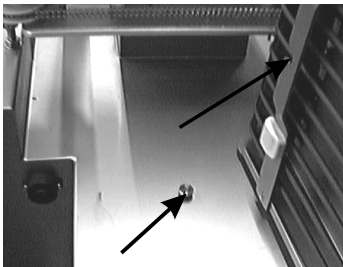

## 12.7. Electrical installation

The conveyor belt is conducted by the food slicer. Plug in the conveyor belt at the corresponding socket-outlet of the food slicer. It is very important to fix the plug of the conveyor belt in the socket-outlet of the food slicer by turning its outer ring.

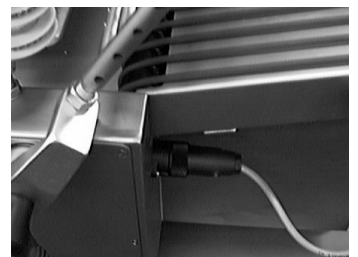

## 13. Operation

The complete operation is done with the food slicer as described in the operation instructions of model 936. The only difference is that you are asked for the distance between the portions, this is valid for all slicing programs. The conveyor belt moves forward each time a slicing program is complete, thus creating a "portion". After having started the machine, there are four things that will interrupt the slicing procedure:

1. The food product has been completely sliced. The machine stops and the end piece holder moves backwards.
2. The portions reach the end of the conveyor belt, the safety switch (see below) is activated and the machine stops.
3. The slicing procedure is interrupted by pushing the key "start/stop".
4. The slicer completes its program

In all above cases a portion has been placed beneath the stacking device. If the machine should then be started, the new portion would be positioned on top of the portion that is already there.

In order to avoid this push the key  first, before restarting the machine.

The conveyor belt then moves forward exactly the distance which is used in the current slicing programme.

However, this only works when the end switch of the conveyor belt is not activated by a portion.

Safety switch

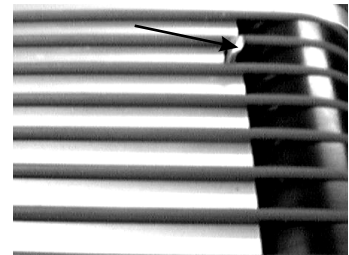

## 14. Cleaning and knife sharpening

Use the same instructions as in the 936 manual

In addition to this you have the possibility to let the conveyor belt turn continuously for easy cleaning. Push the key "cleaning" **more than 5 seconds**. After releasing the key, the conveyor belt starts turning. By pushing the key "cleaning" again, the conveyor belt is stopped.